



EXPOLUX MED ARM

SPRIDNING	WALL WASHER 20°/82°	SKYLTL 15°/41°
EFFEKT	18W	18W
4000K	1614lm	1556lm
3000K	1533lm	1482lm

EGENSKAPER

LIVSLÄNGD	L80 B10 > 50.000h
FÄRGTEMPERATUR	4000K / 3000K. Ra >80. max 2 SCDM
IP-KLASS	IP65
IK-KLASS	IK10
TEMPERATUR	MAX OMGIVNINGSTEMPERATUR TA +40°C
MATERIAL	ARMATURHUS I GJUTEN ALUMINIUM
SKYDDSKLASS	I
DRIVDON	INTERNT DRIVDON 230V / DALI SOM TILLVAL
BEDÖMNING	BYGGVARUBEDÖMNINGEN - ACCEPTERAS

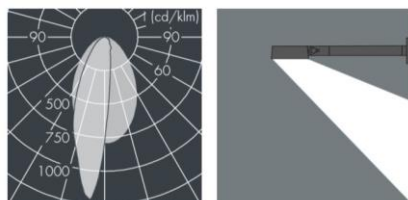
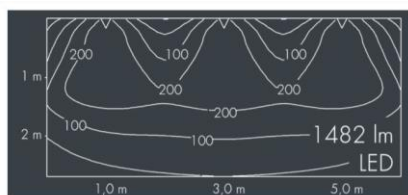
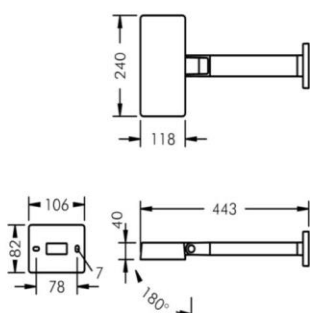

SKYLTL SPRIDNING

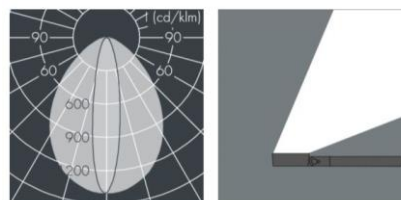
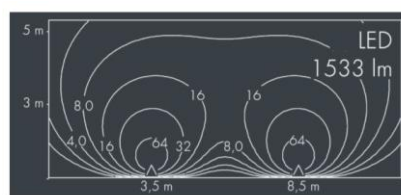

WALL WASHER

EXPOLUX MED VÄGGFÄSTE

SPRIDNING	WALL WASHER 20°/85°	ASYMMETRISK 43°/70°
EFFEKT	18W	18W
4000K	1614lm	1629lm
3000K	1533lm	1551lm

EGENSKAPER

LIVSLÄNGD	L80 B10 > 50.000h
FÄRGTEMPERATUR	4000K / 3000K. Ra >80. max 2 SCDM
IP-KLASS	IP65
IK-KLASS	IK10
TEMPERATUR	MAX OMGIVNINGSTEMPERATUR TA +40°C
MATERIAL	ARMATURHUS I GJUTEN ALUMINIUM
SKYDDSKLASS	I
DRIVDON	INTERNT DRIVDON 230V / DALI SOM TILLVAL
BEDÖMNING	BYGGVARUBEDÖMNINGEN - ACCEPTERAS

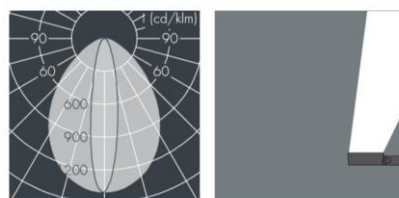
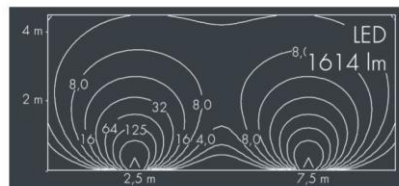
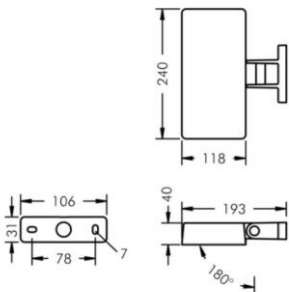

WALL WASHER

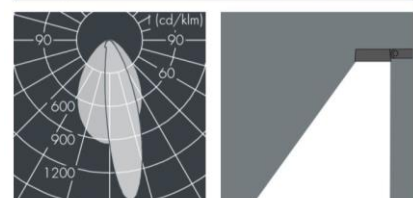
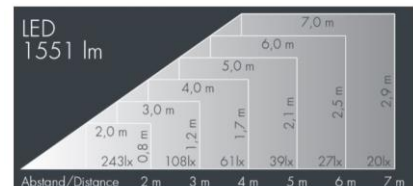

ASYMMETRISK

BESTÄLLNINGSNUMMER

MODELL	A
EXPOLUX	8 990
FÄSTE	B
VÄGGFÄSTE	1
ARM	7
FÄRG	C
SVART (RAL 7021)	4
SILVERGRÅ (likt RAL 9006)	5
VIT (RAL 9002)	6
LJUSFÄRG	D
4000K	5
3000K	6
DRIVDON	E
STANDARD (ON/OFF)	0
DALI	1
1-10V	2
SPRIDNING	F
WALL WASHER	19
ASYMMETRISK	89
SKYLTT	09

DITT BESTÄLLNINGSNUMMER

A

B C D

E F